

Data sheet | Item number: 2022-1601

2-pin carrier terminal block; for DIN-rail 35 x 15 and 35 x 7.5; gray

www.wago.com/2022-1601

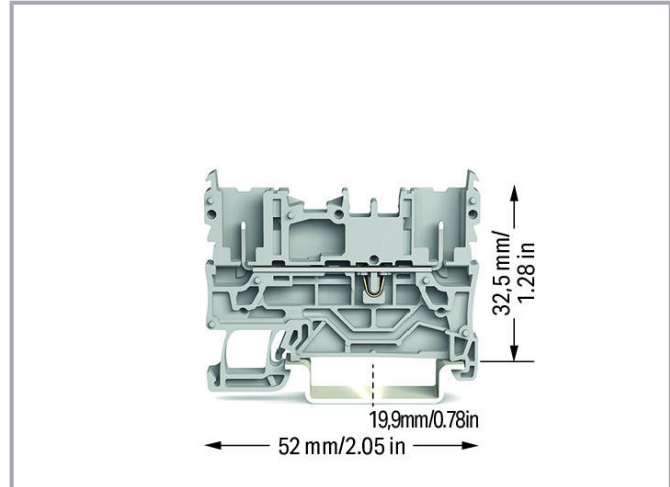
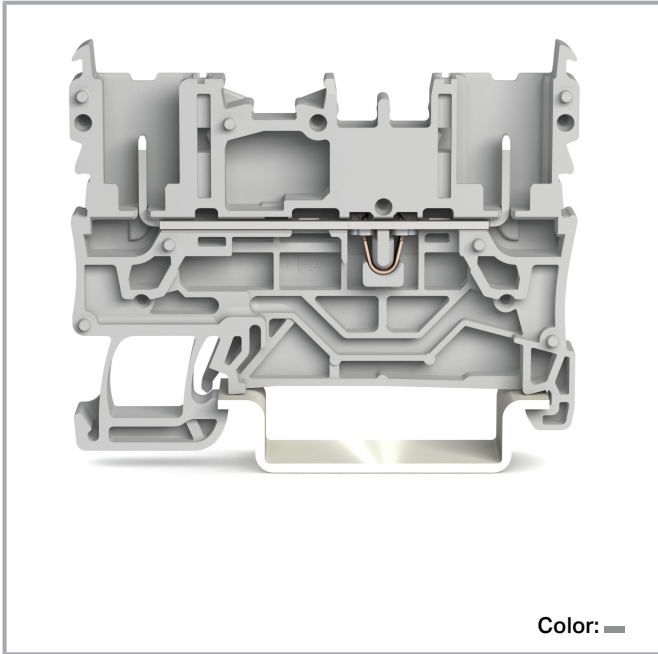

Data

Electrical data

IEC Approvals

Ratings per	IEC/EN 60947-7-1
Rated voltage (III / 3)	690 V
Rated surge voltage (III/3)	6 kV
Rated current	24 A
Rated current 2	28 A
Legend (ratings)	(III / 3) ≙ Overvoltage category III / Pollution degree 3

UL Approvals

Approvals per	UL 1059
Rated voltage UL (Use Group B)	600 V
Rated current UL (Use Group B)	20 A

Subject to changes. Please also observe the further product documentation!

WAGO Corporation
Germantown, WI 53022
Phone: 1-800-DIN-RAIL (346-7245) | Fax: (262) 255-6222
Email: info.us@wago.com | Web: www.wago.us

Do you have any questions about our products?
We are always happy to take your call at (262) 255-6222 or 1 800-DIN-RAIL.

Rated voltage UL (Use Group C)	600 V
Rated current UL (Use Group C)	20 A

CSA Approvals

Approvals per	C22.2 No 158
Rated voltage CSA (Use Group C)	600 V
Rated current CSA (Use Group C)	20 A

Physical data

Width	5.2 mm / 0.205 inch
Height	52 mm / 2.047 inch
Depth from upper edge of DIN-rail	32.5 mm / 1.28 inch

Mechanical data

Design	horizontal type
Mounting type	DIN-35 rail
Marking level	Center/side marking

Material data

Color	gray
Insulation material	Polyamide (PA66)
Flammability class per UL94	V0
Weight	5.5 g

Commercial data

Packaging type	BOX
Country of origin	CN
Customs tariff number	8536904000

Approvals / Certificates

Country specific Approvals

Logo	Approval	Additional Approval Text	Certificate name
	CCA DEKRA Certification B.V.	C22.2 No. 158	2437422

Subject to changes. Please also observe the further product documentation!

WAGO Corporation
Germantown, WI 53022
Phone: 1-800-DIN-RAIL (346-7245) | Fax: (262) 255-6222
Email: info.us@wago.com | Web: www.wago.us

Do you have any questions about our products?
We are always happy to take your call at (262) 255-6222 or 1 800-DIN-RAIL.

UL-Approvals



Logo	Approval	Additional Approval Text	Certificate name
	UL Underwriters Laboratories Inc.	UL 1059	E45172

Counterpart

	Item no. 2022-101 1-conductor female connector; 4 mm ² ; Pin spacing 5.2 mm; 1-pole; 4,00 mm ² ; gray	www.wago.com/2022-101
---	--	--







Required accessories

End plates

	Item no.: 2022-1691 End plate; 1 mm thick; gray	www.wago.com/2022-1691
	Item no.: 2022-1692 End plate; 1 mm thick; orange	www.wago.com/2022-1692















Optional accessories

Jumpers

	Item no.: 2002-400 TOPJOB®S endless jumper; for 2002 series; insulated; 2-way; light-gray	www.wago.com/2002-400
	Item no.: 2002-402 TOPJOB®S jumper; for 2002 series; insulated; 2-way; light-gray	www.wago.com/2002-402
	Item no.: 2002-402/000-005 TOPJOB®S jumper; for 2002 series; insulated; 2-way; red	www.wago.com/2002-402/000-005
	Item no.: 2002-402/000-006 TOPJOB®S jumper; for 2002 series; insulated; 2-way; blue	www.wago.com/2002-402/000-006
	Item no.: 2002-403 TOPJOB®S jumper; for 2002 series; insulated; 3-way; light-gray	www.wago.com/2002-403
	Item no.: 2002-403/000-005 TOPJOB®S jumper; for 2002 series; insulated; 3-way; red	www.wago.com/2002-403/000-005

Subject to changes. Please also observe the further product documentation!

















	Item no.: 2002-403/000-006 TOPJOB®S jumper; for 2002 series; insulated; 3-way; blue	www.wago.com/2002-403/000-006
	Item no.: 2002-404 TOPJOB®S jumper; for 2002 series; insulated; 4-way; light-gray	www.wago.com/2002-404
	Item no.: 2002-404/000-005 TOPJOB®S jumper; for 2002 series; insulated; 4-way; red	www.wago.com/2002-404/000-005
	Item no.: 2002-404/000-006 TOPJOB®S jumper; for 2002 series; insulated; 4-way; blue	www.wago.com/2002-404/000-006
	Item no.: 2002-405 TOPJOB®S jumper; for 2002 series; insulated; 5-way; light-gray	www.wago.com/2002-405
	Item no.: 2002-405/000-005 TOPJOB®S jumper; for 2002 series; insulated; 5-way; red	www.wago.com/2002-405/000-005
	Item no.: 2002-405/000-006 TOPJOB®S jumper; for 2002 series; insulated; 5-way; blue	www.wago.com/2002-405/000-006
	Item no.: 2002-405/011-000 TOPJOB®S jumper; Wye configuration; for 2002 series; insulated; 3-way (1-3-5); light-gray	www.wago.com/2002-405/011-000
	Item no.: 2002-406 TOPJOB®S jumper; for 2002 series; insulated; 6-way; light-gray	www.wago.com/2002-406
	Item no.: 2002-406/000-005 TOPJOB®S jumper; for 2002 series; insulated; 6-way; red	www.wago.com/2002-406/000-005
	Item no.: 2002-406/000-006 TOPJOB®S jumper; for 2002 series; insulated; 6-way; blue	www.wago.com/2002-406/000-006
	Item no.: 2002-406/020-000 TOPJOB®S jumper; Delta configuration; for 2002 series; insulated; 6-way (1-2, 3-4, 5-6); light-gray	www.wago.com/2002-406/020-000
	Item no.: 2002-407 TOPJOB®S jumper; for 2002 series; insulated; 7-way; light-gray	www.wago.com/2002-407
	Item no.: 2002-407/000-005 TOPJOB®S jumper; for 2002 series; insulated; 7-way; red	www.wago.com/2002-407/000-005
	Item no.: 2002-407/000-006 TOPJOB®S jumper; for 2002 series; insulated; 7-way; blue	www.wago.com/2002-407/000-006

Subject to changes. Please also observe the further product documentation!

















WAGO Corporation
 Germantown, WI 53022
 Phone: 1-800-DIN-RAIL (346-7245) | Fax: (262) 255-6222
 Email: info.us@wago.com | Web: www.wago.us

Do you have any questions about our products?
 We are always happy to take your call at (262) 255-6222 or 1 800-DIN-RAIL.

	Item no.: 2002-408 TOPJOB®S jumper; for 2002 series; insulated; 8-way; light-gray	www.wago.com/2002-408
	Item no.: 2002-408/000-005 TOPJOB®S jumper; for 2002 series; insulated; 8-way; red	www.wago.com/2002-408/000-005
	Item no.: 2002-408/000-006 TOPJOB®S jumper; for 2002 series; insulated; 8-way; blue	www.wago.com/2002-408/000-006
	Item no.: 2002-409 TOPJOB®S jumper; for 2002 series; insulated; 9-way; light-gray	www.wago.com/2002-409
	Item no.: 2002-409/000-005 TOPJOB®S jumper; for 2002 series; insulated; 9-way; red	www.wago.com/2002-409/000-005
	Item no.: 2002-409/000-006 TOPJOB®S jumper; for 2002 series; insulated; 9-way; light-gray	www.wago.com/2002-409/000-006
	Item no.: 2002-410 TOPJOB®S jumper; for 2002 series; insulated; 10-way; light-gray	www.wago.com/2002-410
	Item no.: 2002-410/000-005 TOPJOB®S jumper; for 2002 series; insulated; 10-way; red	www.wago.com/2002-410/000-005
	Item no.: 2002-410/000-006 TOPJOB®S jumper; for 2002 series; insulated; 10-way; blue	www.wago.com/2002-410/000-006
	Item no.: 2002-423 TOPJOB®S endless jumper; for 2002 series; insulated; 2-way (1-3); light-gray	www.wago.com/2002-423
	Item no.: 2002-423/000-005 TOPJOB®S endless jumper; for 2002 series; insulated; 2-way (1-3); red	www.wago.com/2002-423/000-005
	Item no.: 2002-423/000-006 TOPJOB®S endless jumper; for 2002 series; insulated; 2-way (1-3); blue	www.wago.com/2002-423/000-006
	Item no.: 2002-433 TOPJOB®S jumper; for 2002 series; insulated; 2-way (1-3); light-gray	www.wago.com/2002-433
	Item no.: 2002-434 TOPJOB®S jumper; for 2002 series; insulated; 2-way (1-4); light-gray	www.wago.com/2002-434
	Item no.: 2002-435 TOPJOB®S jumper; for 2002 series; insulated; 2-way (1-5); light-gray	www.wago.com/2002-435

Subject to changes. Please also observe the further product documentation!

















	Item no.: 2002-436 TOPJOB®S jumper; for 2002 series; insulated; 2-way (1-6); light-gray	www.wago.com/2002-436
	Item no.: 2002-437 TOPJOB®S jumper; for 2002 series; insulated; 2-way (1-7); light-gray	www.wago.com/2002-437
	Item no.: 2002-438 TOPJOB®S jumper; for 2002 series; insulated; 2-way (1-8); light-gray	www.wago.com/2002-438
	Item no.: 2002-439 TOPJOB®S jumper; for 2002 series; insulated; 2-way (1-9); light-gray	www.wago.com/2002-439
	Item no.: 2002-440 TOPJOB®S jumper; for 2002 series; insulated; 2-way (1-10); light-gray	www.wago.com/2002-440
	Item no.: 2002-472 TOPJOB®S staggered jumper; for 2002 and 2003 series; insulated; 2-way; light-gray	www.wago.com/2002-472
	Item no.: 2002-473 TOPJOB®S staggered jumper; for 2002 and 2003 series; insulated; 3-way; light-gray	www.wago.com/2002-473
	Item no.: 2002-473/011-000 TOPJOB®S staggered jumper; for 2002 and 2003 series; 2-way (preconfigured 1-3); light-gray	www.wago.com/2002-473/011-000
	Item no.: 2002-474 TOPJOB®S staggered jumper; for 2002 and 2003 series; insulated; 4-way; light-gray	www.wago.com/2002-474
	Item no.: 2002-475 TOPJOB®S staggered jumper; for 2002 and 2003 series; insulated; 5-way; light-gray	www.wago.com/2002-475
	Item no.: 2002-475/011-000 TOPJOB®S staggered jumper; for 2002 and 2003 series; insulated; 3-way (preconfigured 1-3-5); light-gray	www.wago.com/2002-475/011-000
	Item no.: 2002-476 TOPJOB®S staggered jumper; for 2002 and 2003 series; insulated; 6-way; light-gray	www.wago.com/2002-476
	Item no.: 2002-477 TOPJOB®S staggered jumper; for 2002 and 2003 series; insulated; 7-way; light-gray	www.wago.com/2002-477
	Item no.: 2002-477/011-000 TOPJOB®S staggered jumper; for 2002 and 2003 series; insulated; 4-way (preconfigured 1-3-5-7); light-gray	www.wago.com/2002-477/011-000
	Item no.: 2002-478 TOPJOB®S staggered jumper; for 2002 and 2003 series; insulated; 8-way; light-gray	www.wago.com/2002-478
	Item no.: 2002-479 TOPJOB®S staggered jumper; for 2002 and 2003 series; insulated; 9-way; light-gray	www.wago.com/2002-479
	Item no.: 2002-479/011-000 TOPJOB®S staggered jumper; for 2002 and 2003 series; insulated; 5-way (preconfigured 1-3-5-7-9); light-gray	www.wago.com/2002-479/011-000

Subject to changes. Please also observe the further product documentation!

WAGO Corporation
 Germantown, WI 53022
 Phone: 1-800-DIN-RAIL (346-7245) | Fax: (262) 255-6222
 Email: info.us@wago.com | Web: www.wago.us

Do you have any questions about our products?
 We are always happy to take your call at (262) 255-6222 or 1 800-DIN-RAIL.

















	Item no.: 2002-480 TOPJOB®S staggered jumper; for 2002 and 2003 series; insulated; 10-way; light-gray	www.wago.com/2002-480
	Item no.: 2002-481 TOPJOB®S staggered jumper; for 2002 and 2003 series; insulated; 11-way; light-gray	www.wago.com/2002-481
	Item no.: 2002-481/011-000 TOPJOB®S staggered jumper; for 2002 and 2003 series; insulated; 6-way (preconfigured 1-3-5-7-9-11); light-gray	www.wago.com/2002-481/011-000
	Item no.: 2002-482 TOPJOB®S staggered jumper; for 2002 and 2003 series; insulated; 12-way; light-gray	www.wago.com/2002-482
Push-in type wire jumper		
	Item no.: 2009-412 TOPJOB®S wire jumper; insulated; 60 mm long; conductor cross section 1.5 mm ² ; suitable for 2001, 2002, 2003 and 2022 series terminal blocks; gray	www.wago.com/2009-412
	Item no.: 2009-414 TOPJOB®S wire jumper; insulated; 110 mm long; conductor cross section 1.5 mm ² ; suitable for 2001, 2002, 2003 and 2022 series terminal blocks; gray	www.wago.com/2009-414
	Item no.: 2009-414/000-005 Push-in type wire jumper; 1.5 mm ² ; insulated; 110 mm long; black	www.wago.com/2009-414/000-005
	Item no.: 2009-414/000-006 Push-in type wire jumper; insulated; 110 mm long; black	www.wago.com/2009-414/000-006
	Item no.: 2009-416 TOPJOB®S wire jumper; insulated; 250 mm long; conductor cross section 1.5 mm ² ; suitable for 2001, 2002, 2003 and 2022 series terminal blocks; gray	www.wago.com/2009-416
Carrier rail		
	Item no.: 210-112 Steel carrier rail; 35 x 7.5 mm; 1 mm thick; 2 m long; slotted; according to EN 60715; "Hole width 25 mm; silver-colored	www.wago.com/210-112
	Item no.: 210-113 Steel carrier rail; 35 x 7.5 mm; 1 mm thick; 2 m long; unslotted; according to EN 60715; silver-colored	www.wago.com/210-113
	Item no.: 210-114 Steel carrier rail; 35 x 15 mm; 1.5 mm thick; 2 m long; unslotted; similar to EN 60715; silver-colored	www.wago.com/210-114
	Item no.: 210-115 Steel carrier rail; 35 x 7.5 mm; 1 mm thick; 2 m long; slotted; according to EN 60715; "Hole width 18 mm; silver-colored	www.wago.com/210-115
	Item no.: 210-118 Steel carrier rail; 35 x 15 mm; 2.3 mm thick; 2 m long; unslotted; according to EN 60715; silver-colored	www.wago.com/210-118
	Item no.: 210-196 Aluminum carrier rail; 35 x 8.2 mm; 1.6 mm thick; 2 m long; unslotted; similar to EN 60715; silver-colored	www.wago.com/210-196
	Item no.: 210-197	

Subject to changes. Please also observe the further product documentation!

WAGO Corporation
Germantown, WI 53022
Phone: 1-800-DIN-RAIL (346-7245) | Fax: (262) 255-6222
Email: info.us@wago.com | Web: www.wago.us

Do you have any questions about our products?
We are always happy to take your call at (262) 255-6222 or 1 800-DIN-RAIL.

	Steel carrier rail; 35 x 15 mm; 1.5 mm thick; 2 m long; slotted; similar to EN 60715; silver-colored	www.wago.com/210-197
Item no.: 210-198		
	Copper carrier rail; 35 x 15 mm; 2.3 mm thick; 2 m long; unslotted; according to EN 60715; copper-colored	www.wago.com/210-198
Coding		
	Item no.: 2022-100 Carrier with 6 coding pins; for coding of female plugs; orange	www.wago.com/2022-100
Tools		
	Item no.: 210-720 Operating tool; Blade: 3.5 x 0.5 mm; with a partially insulated shaft; multicoloured	www.wago.com/210-720
Marking accessories		
	Item no.: 2002-161 Adaptor; gray	www.wago.com/2002-161
	Item no.: 2009-110 Marking strips; for Smart Printer; on reel; not stretchable; plain; snap-on type; white	www.wago.com/2009-110
	Item no.: 2009-115 WMB-Inline; for Smart Printer; 1500 pieces on roll; stretchable 5 - 5.2 mm; plain; snap-on type; white	www.wago.com/2009-115
	Item no.: 2009-145 Mini-WSB Inline; for Smart Printer; 1700 pieces on roll; stretchable 5 - 5.2 mm; plain; snap-on type; white	www.wago.com/2009-145
	Item no.: 2009-191 Group marker carrier	www.wago.com/2009-191
	Item no.: 2009-192 Group marker carrier	www.wago.com/2009-192
	Item no.: 2009-193 Group marker carrier	www.wago.com/2009-193
	Item no.: 2009-198 Adaptor; gray	www.wago.com/2009-198
	Item no.: 248-501 Mini-WSB marking card; as card; not stretchable; plain; snap-on type; white	www.wago.com/248-501
	Item no.: 793-501 WMB marking card; as card; not stretchable; plain; snap-on type; white	www.wago.com/793-501
	Item no.: 793-5501 WMB marking card; as card; for terminal block width 5 - 17.5 mm; stretchable 5 - 5.2 mm; plain; snap-on type; white	www.wago.com/793-5501

Downloads

Documentation

Bid Text

Subject to changes. Please also observe the further product documentation!

WAGO Corporation
 Germantown, WI 53022
 Phone: 1-800-DIN-RAIL (346-7245) | Fax: (262) 255-6222
 Email: info.us@wago.com | Web: www.wago.us

Do you have any questions about our products?
 We are always happy to take your call at (262) 255-6222 or 1 800-DIN-RAIL.



2022-1601 X81 - Datei	May 20, 2019	xml 4.4 kB	Download
2022-1601 docx - Datei	May 20, 2019	docx 15.5 kB	Download
Additional Information Technical explanations	Apr 3, 2019	pdf 2.2 MB	Download

CAD files

CAD data

2D/3D Models 2022-1601		URL	Download
------------------------	--	-----	----------

CAE data

ZUKEN Portal 2022-1601		URL	Download
------------------------	--	-----	----------

Environmental Product Compliance

Compliance Search

Environmental Product Compliance 2022-1601 2-pin carrier terminal block; for DIN-rail 35 x 15 and 35 x 7.5; gray		URL	Download
---	--	-----	----------

Installation Notes

Installation

Subject to changes. Please also observe the further product documentation!

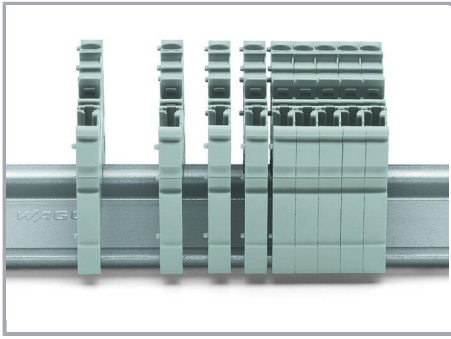

Snap individual carrier terminal blocks onto the DIN-rail and slide together.

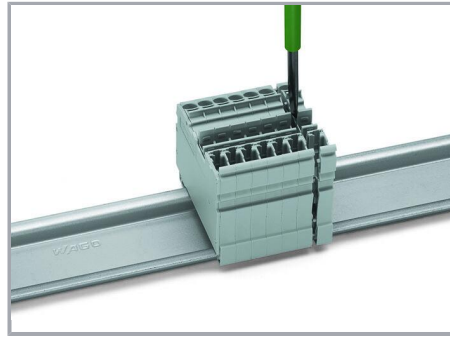

Open the assembly by laterally sliding a block via operating tool (3.5 x 0.5 mm blade).

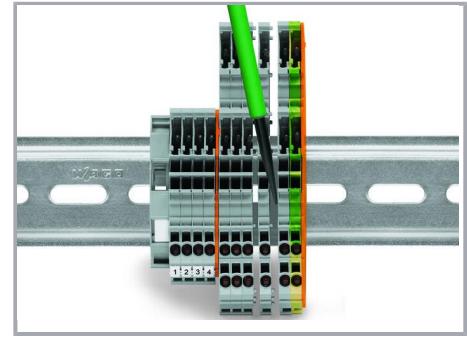

Separate terminal block assembly and slide individual terminal blocks laterally using an operating tool.

Commoning

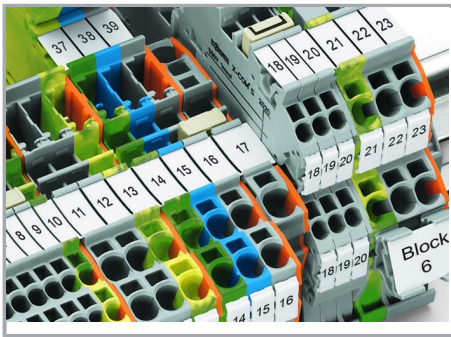

Commoning X-COM®S-SYSTEM Terminal Blocks using jumpers for TOPJOB® S Terminal Blocks. An end plate provides connection to TOPJOB® S Terminal Blocks. 2020 and 2022 Series Terminal Blocks are combinable. Jumper slots are on the same level for both series.

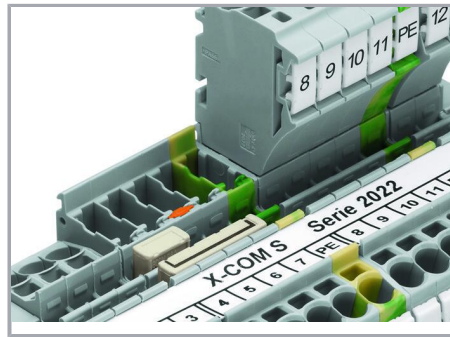

Pairing push-in comb style jumpers.

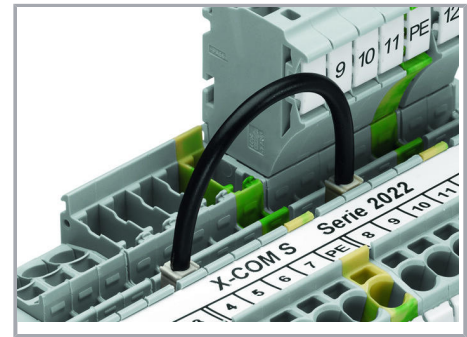

Commoning with push-in type wire jumper.

Testing

Subject to changes. Please also observe the further product documentation!

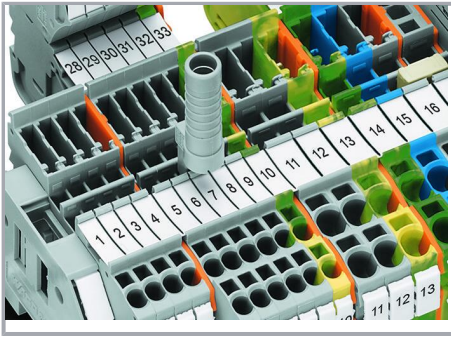

Test plug adapter (2009-174) for 4 mm test plugs or banana plugs – also suitable for X-COM®S-SYSTEM-MINI Terminal Blocks.

Coding

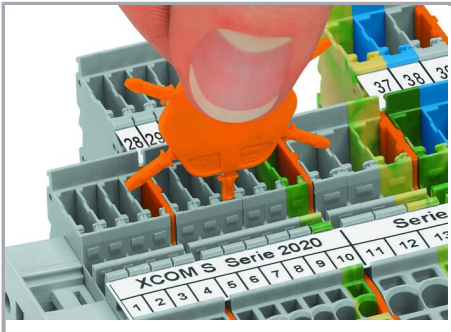

Insert coding pin into the corresponding slot and twist it off.



Coding a female plug: remove coding finger using a suitable tool.

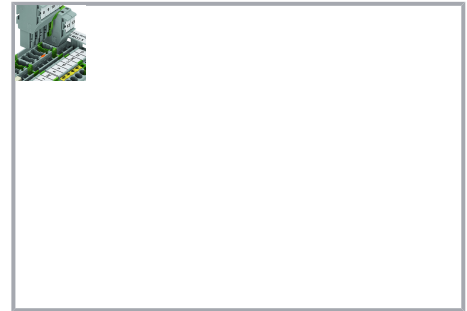

Insert a coding pin (2022-100) into the corresponding location of the carrier terminal block.

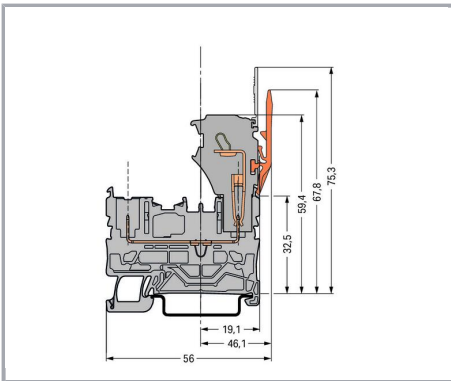

Marking

Subject to changes. Please also observe the further product documentation!

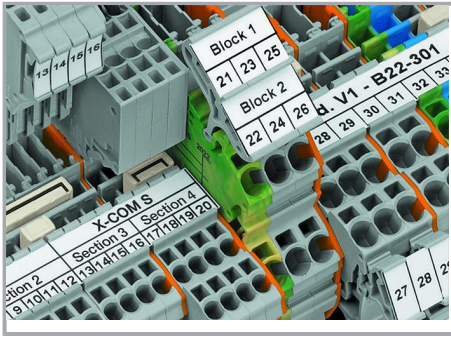

Clear marking via large marking area

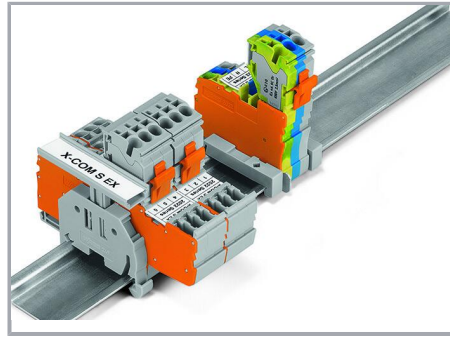

Group marking with height-adjustable group marker carrier (2009-163)

Safety

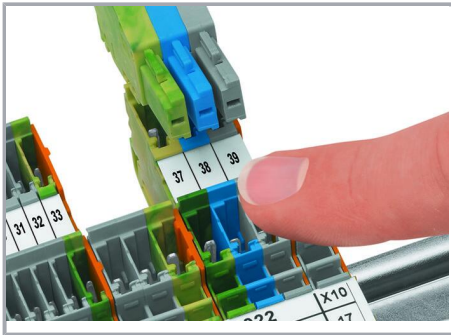

Carrier terminal blocks and female plugs are touch-proof.

Subject to changes. Please also observe the further product documentation!

WAGO Corporation
Germantown, WI 53022
Phone: 1-800-DIN-RAIL (346-7245) | Fax: (262) 255-6222
Email: info.us@wago.com | Web: www.wago.us

Do you have any questions about our products?
We are always happy to take your call at (262) 255-6222 or 1 800-DIN-RAIL.